

JOINT MEMORANDUM TO PARLIAMENT

SUBMITTED BY

HON. MINISTER FOR FOOD & AGRICULTURE
(HON. DR. OWUSU AFRIYIE AKOTO)

AND

HON. MINISTER OF FINANCE
(HON. KEN OFORI - ATTA)

REQUEST FOR APPROVAL FOR €10,000,000.00 LOAN
UNDER THE CZECH EXPORT BANK FACILITY

TO

GOVERNMENT OF GHANA

FOR THE

SUPPLY OF SETS OF CABRIO COMPACT TRACTORS AND
GLOBAL SYSTEM FOR DISTRIBUTION TO SMALL AND MEDIUM
SCALE FARMERS

Dated ²⁶2018 November, 2018

1.0 ACTION REQUIRED

Parliament is respectfully invited to consider and approve a request for a loan of **Ten Million Euros (€10,000,000.00)** from Czech Export Bank (CEB) to the Ministry of Food and Agriculture in the form of a Supplier's Credit Agreement for the supply of Global Multipurpose Mini Tractors (Global System) and CABRIO Compact Tractors (Refer to Appendix A).

This facility is in support of the Ministry of Food and Agriculture's Mechanisation Strategy (FASDEP II and METASIP III), which aims at raising agricultural productivity; reducing poverty, provision of raw materials to industries and enhancing food security through the supply of agricultural machinery and equipment for onward sale to farmers across the country.

2.0 BACKGROUND

The major constraints affecting the agricultural sector, as captured in the Medium Term Agriculture Sector Investment Plan II (MET SIP II) (2014-2017), include declining agricultural productivity, low profitability from farming and fishing due to high cost of operations, low access to productive factors and various critical services along the value chain such as land, labour, mechanization, irrigation, credit, extension services, processing and limited market information and intelligence.

3.0 JUSTIFICATION FOR GOVERNMENT ACTION

The inadequacy of agricultural machinery and equipment in the country is as a result of high initial capital investment with long period of economic returns. In a country of high cost of capital, it is highly unattractive for the private sector and farmers to invest in agricultural machinery. This situation underscores the need for Government to support farmers with machinery and equipment to achieve targeted level of agricultural productivity and production.

Beginning in 2003, the government re-emphasized the importance of mechanization and directly engaged in tractor imports, and supported companies to establish

subsidized agricultural mechanization service centers in the last few years. These machinery are sold under concessional terms to enable farmers procure them. This policy by government has greatly led to acquisition of farm machinery by farmers for their farms operations. Also beneficiaries rendered services to neighbouring farmers who are not economically endowed to acquire own machinery.

Among the brand of machines imported were CABRIO Compact Tractors which are normally meant for medium scale farmers whilst Global System is a hand held machinery meant for small scale farmers. The CABRIO is designed and conditioned to work on muddy fields due to its gross weight, size and surface area of the tyres. It also has a power take off (PTO) shaft and two point linkages, which means that equipment and accessories can both be attached in the front and rear. This is unique as compared to other tractors in the country and gives CABRIO Compact Tractors an advantage over similar Compact tractors in the system.

The supplier in collaboration with Agricultural Engineering Services Directorate of Ministry of Food and Agriculture had designed reaping equipment, which is mounted in front of the CABRIO Compact Tractor for harvesting paddy in the fields. After reaping the paddy there is a thresher, which is, attached to the rear PTO the tractors, where the paddy is threshed and winnowed which significantly reduce the drudgery rice farmers go through during harvesting.

Some of the arable lands have shallow top soils and deep ploughing with heavy duty tractors buries the top soils deeper; this leads to loss of soil nutrients to plants. The CABRIO Compact Tractors is appropriate for land preparation in areas with shallow subsoils.

4.0 POLICY GOAL

The policy goal of this project is to increase the number of agricultural machinery and equipment with the view of improving agricultural productivity and invariably increase the incomes of farmers and create decent jobs for the youth.

5.0 SYNERGY OF THE PROJECT WITH POLICY INITIATIVES OF GOVERNMENT

The agricultural machinery and equipment that will be supplied will be used to support smallholder and medium scale farmers throughout the country for the production of food security crops such as maize, rice, cassava, vegetables and soya.

It is expected that the timely delivery and deployment of the machines from Czech Republic will greatly contribute to the success of Government's flagship programmes "Planting for Food & Jobs" and "One District – One Factory".

6.0 IMPLEMENTATION PLAN

The beneficiaries of these facilities shall enjoy a concessional purchase arrangement and a subsidy rate of 40% from MOFA. Proceeds from the sales of the machinery will be paid into an MOF/MOFA Escrow account at the Bank of Ghana to be used to meet Governments' debt obligation under the Credit Facility.

MOFA and staff of the Department of Agriculture at the District Assemblies will monitor the operations and management of the machinery. The local agent BIGA International Limited incorporated in Ghana by Knights of the Czech Republic will take care of after sales services.

The supplier will train ten (10) MOFA technicians and ten (10) private mechanics in Czech Republic on the operation and maintenance of the CABRIO Compact Tractors. All the cost will be borne by the supplier.

7.0 TAX EXEMPTION

All goods to be procured under this agreement shall be exempted from duties and taxes. Details of the total tax to be waived shall be presented to august House for consideration and approval.

8.0 FINANCING TERMS

The characteristics of the credit facility included the following:

Loan Amount: €10,000,000.00

Interest: 0.0 % per annum

Availability Period: 1 year

Repayment: 4 years

Management fee: 0.0%

Commitment fee: 0%

Requisite guarantee: Deferred Letters of Credit from Bank of Ghana

Insurance cover: At the expense of the supplier

9.0. CABINET APPROVAL

Cabinet at its Fourth Government Retreat held on Saturday, 3rd November, 2018 at Senchi gave approval for the Supplier's Credit Agreement and has recommended same to the August House for consideration and approval.

10.0 CONCLUSION

In view of the immense benefits to be derived from the implementation of the project, Parliament is respectfully requested to consider and approve the Supplier's Credit Agreement for the Ministry of Food and Agriculture to enable the Ministry import agricultural machinery and equipment from the Czech Republic to strengthen Agricultural Mechanization Service Enterprise Centers (AMSECs).

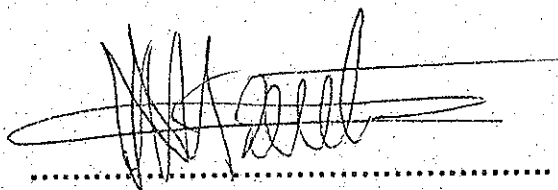

HON. DR. OWUSU AFRIYIE AKOTO
MINISTER FOR AGRICULTURE

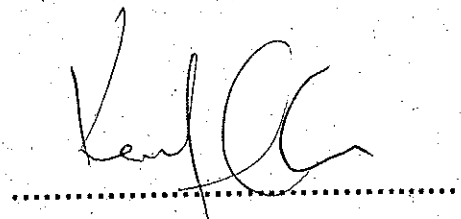

HON. KEN OFORI-ATTA
MINISTER FOR FINANCE

03rd NOVEMBER, 2018

SCHEDULE 1

SUPPLIERS CREDIT AGREEMENT

BETWEEN

THE GOVERNMENT OF THE REPUBLIC OF GHANA
REPRESENTED BY THE MINISTRY OF FOOD AND AGRICULTURE
("BUYER")

AND

KNIGHT A.S.
(SUPPLIER)

FOR THE SUPPLY OF THREE HUNDRED (300) SETS OF GLOBAL SYSTEMS
AND TWO HUNDRED AND TWENTY (220) COMPACT TRACTORS
INCLUDING THEIR VARIOUS ACCESSORIES AND SPARE PARTS
(EQUIPMENT)

NOVEMBER, 2018

THIS SUPPLIERS CREDIT AGREEMENT ("Agreement") is made this..... day of...2018 between **KNIGHTS A.S.** a company incorporated under the laws of the Czech Republic with registered office at Ke Kaplicce 387, 252 41, Dolni Brezany, Czech Republic, represented by DR. KARL LARYEA, the Chief Executive Officer, (hereinafter referred to as the "SUPPLIER") and **THE GOVERNMENT OF THE REPUBLIC OF GHANA** represented by the **MINISTRY OF FOOD AND AGRICULTURE**, P. O. Box M37, Accra, Ghana (hereinafter referred to as the "BUYER")

WHEREAS:

1. The BUYER has made a request for the purchase of Three Hundred (300) sets of GLOBAL Multipurpose Mini Tractors and Two Hundred and Twenty (220) Compact Tractors including active and passive accessories with tools and spare parts for small and medium scale farmers in the Republic of Ghana;
2. The Czech Export Bank (CEB), through the SUPPLIER, has indicated its readiness to make available to the BUYER a credit facility of Ten Million Euros (€10,000,000.00) which the BUYER is willing and ready to access for the said purchase;
3. The SUPPLIER is prepared to supply the three hundred (300) Sets of GLOBAL Systems and two hundred and twenty (220) Compact Tractors including their various accessories and spare parts (Equipment) on credit and the BUYER is prepared to buy and pay the purchase prize pursuant to the specification, scope, terms and conditions hereinafter mentioned and agreed upon by both Parties

NOW THEREFORE THE PARTIES HERETO AGREE AS FOLLOWS:

**ARTICLE 1
INTERPRETATION**

1.1. In this Agreement, unless the context otherwise requires, the following expressions have the following meanings:

"Agreement" means this Suppliers Credit Agreement;

"business day" means any day other than a Saturday, Sunday or bank holiday;

"BUYER" means the Government of the Republic of Ghana represented by the Ministry of Food and Agriculture;

"Purchase Price" means Ten Million Euros (€10,000,000.00) secured by the SUPPLIER from the Czech Export Bank (CEB) for the procurement of the Equipment on behalf of the BUYER.

"Delivery Date" means the date on which the Equipment are to be delivered as Stipulated in the BUYER's order and accepted by the Seller;

"Equipment" means the Three Hundred (300) complete sets of GLOBAL Multipurpose Min Tractors and Two Hundred and Twenty (220) Compact Tractors including the active and passive accessories and spare parts backup for small and medium scale farming industry in the Republic of Ghana or any instalment of same;

"month" means a calendar month;

"SUPPLIER" means KNIGHTS A.S a company incorporated under the laws of the Czech Republic with registered office at Ke Kaplicce 387, 252 41, Dolni Brezany, Czech Republic,

1.2. Unless the context otherwise requires, each reference in this Agreement to:

- a. "writing", and any cognate expression, includes a reference to any communication effected by electronic or facsimile transmission similar means;
- b. a statute or a provision of a statute is a reference to that statute or provision as amended or re-enacted at the relevant time;

ARTICLE 2 SCOPE AND PURCHASE PRICE

- 2.1 Subject to the terms and conditions of this Agreement, the SUPPLIER shall supply and deliver to the BUYER CIF Tema - Ghana, Three Hundred (300) complete sets of GLOBAL Multipurpose Mini Tractors and Two Hundred and Twenty (220) Compact Tractors including the active and passive accessories and spare parts backup for small and medium scale farming industry in Republic of Ghana (hereinafter referred to as the "Equipment").
- 2.2 The Purchase Price for the Equipment shall be quoted in Euros (€).
- 2.3 The total Purchase Price for all the Equipment and Services to be supplied under this Agreement shall be **Ten Million Euros (€10,000,000.00)** secured by the SUPPLIER from the Czech Export Bank (CEB) for the procurement of the Equipment on behalf of the BUYER.

- 2.4 The price list for the various complete sets of the GLOBAL Multipurpose Mini Tractor and the Compact Tractors including all the accessories shall be as contained in schedule 1.
- 2.5 The BUYER shall pay 100% of the Purchase Price by means of irrevocable confirmed letters of credit according to UCP 600 issued by the BUYER's Bankers available with Czech Export Bank, A.S. Vodickova 34, 111 21 Prague, Czech Republic by deferred payment of up to 4 years with semi-annual payments (CIF Tema) upon submission of the following documents:
- i. Commercial Invoices (showing the total shipment price);
 - ii. Packing Lists (showing the set of pieces of the Global systems and the Compact Tractors);
 - iii. Insurance Cover Certificate (value insured is 110% of Cost and Freight),
 - iv. Certificate of Origin;
 - v. Full set of Bill of Lading issued to order and blank endorsed Notify: BUYER marked freight prepaid;
- 2.6 The Deferred Letter of Credit shall be issued in form and substance acceptable to the SUPPLIER and Czech Export Bank.
- 2.7 All costs arising outside the Czech Republic shall be borne by the BUYER.
- 2.8 All charges arising in the Czech Republic shall be borne by the SUPPLIER
- 2.9 The Purchase Price is exclusive of any applicable value added tax, excise, sales taxes or levies of a similar nature which are imposed or charged by any competent fiscal authority in respect of the Equipment or any additional costs which do not correspond with CIF conditions and the cost of unloading the Equipment at site as well as other fees charged outside the Czech Republic
- 2.10 The BUYER shall guarantee the payment of the Purchase Price by a Deferred Letter of Credit (LC) issued by a reputable bank in Ghana and the Purchase Price shall be paid back in full to the SUPPLIER/CEB within 4 years in semi-annual instalments.
- 2.11 The SUPPLIER shall supply to the BUYER 300 sets of the GLOBAL SYSTEM and 220 sets of Compact Tractors with their spare parts backup in ten (10) partial instalments which supply shall commence within three (3) Months from the effective date and shall be completed within twelve (12) months from the effective date.

ARTICLE 3 DELIVERY

- 3.1 The SUPPLIER shall deliver the Equipment to Tema Port, Ghana in accordance with INCOTERMS 2010 **(CIF-INCOTERMS 2010)**.
- 3.2 The SUPPLIER shall deliver to the BUYER 300 sets of the GLOBAL SYSTEM and 220 sets of Compact Tractors with their spare parts backup in ten (10) partial instalments which delivery shall commence within three (3) Months from the effective date of this Agreement and shall be completed within twelve (12) months from the effective date.
- 3.3 The SUPPLIER shall supply a minimum set of 100 pieces of the Global Systems every quarter.
- 3.4 The SUPPLIER shall supply the Equipment in its own name and at its own expense pursuant to INCOTERMS-2010.
- 3.5 The SUPPLIER shall not be liable for any delay in the delivery of the Equipment that is caused by a Force Majeure Event or a failure of the BUYER to provide the SUPPLIER with adequate delivery instructions or any other instructions that are relevant to the supply of the Equipment.
- 3.6 Delivery shall be completed when the Equipment have been unloaded at the Agricultural Engineering Services Directorate yard, Ghana and upon the receipt of the Equipment by a duly authorised agent, employee or location representative of the BUYER.
- 3.7 The SUPPLIER shall exercise due professional care at every stage of the delivery process.
- 3.8 The cost of transportation and insurance for the Equipment from the Czech Republic to Tema Port shall be borne by the SUPPLIER.
- 3.9 The transfer of responsibility for the Equipment from the SUPPLIER to the BUYER shall occur upon the effective delivery of the Equipment to the SUPPLIER under this Article.

ARTICLE 4 SPARE PARTS

- 4.1 The SUPPLIER shall in collaboration with BIGA International Ltd (BIGA) ensure the availability of the requisite spare parts back up for up to fifteen (15) years after the delivery date.
- 4.2 The SUPPLIER shall in collaboration with BIGA establish a Tractor Service and Sale Service in the middle and Northern parts of the Republic of Ghana in addition to the existing one in Accra.
- 4.3 The BUYER shall assist the SUPPLIER in the leasing of sites to be used by the SUPPLIER and BIGA to ensure the smooth supply of the spare parts and other GLOBAL and Compact Tractor services to the small and medium scale farmers.

ARTICLE 5 INSPECTION

- 5.1 The BUYER or such persons authorised by the BUYER shall inspect the Equipment in the Czech Republic prior to the shipment of the Equipment by the SUPPLIER.
- 5.2 All expenses and costs associated with the inspection of the Equipment by the BUYER shall be borne by the BUYER.

ARTICLE 6 DELAYS

- 6.1 The SUPPLIER shall deliver the Equipment in accordance with all stated delivery dates and agreed timelines under this Agreement.
- 6.2 If the SUPPLIER fails to supply any of the Equipment in accordance with the stated delivery dates, the SUPPLIER shall pay a charge of 0.2% of the Purchase Price of the undelivered Equipment for each month for which such delivery date is extended unless such delay was caused by a force majeure.
- 6.3 The SUPPLIER may suspend individual deliveries of the Equipment upon a failure by the BUYER to discharge its payment obligations under this Agreement.
- 6.4 The right of the SUPPLIER to suspend delivery of Equipment under Article 6.3 shall be without prejudice to the right of the SUPPLIER to claim damages pursuant to the terms of this Agreement.

ARTICLE 7 TRAINING

- 7.1 The SUPPLIER shall at its own expense provide four (4) weeks training course for Six (6) Technicians or Engineers from the Agricultural Engineering Services Department of the Ministry of Agriculture, Ghana in the Czech Republic.
- 7.2 The Seller shall at its own expense provide four (4) weeks training in the Republic of Ghana for twenty (20) specialists nominated by the BUYER.

ARTICLE 8 AMENDMENTS AND MODIFICATIONS

- 8.1 The BUYER may within ten (10) business days from the effective date of this Agreement make changes to the technical specifications of the Equipment or as the case be cancel the delivery or a part of same.
- 8.2 The Parties agree that email signatures of the Parties hereto on the email copy are to be construed as original.
- 8.3 This Agreement may be amended or modified from time to time only by the written agreement of all the Parties. Each such instrument shall be reduced into writing and shall be designated on its face as an amendment to this Agreement.

ARTICLE 9 NOTICES

- 9.1 All notices, requests, consents and other communications required under this Agreement shall be in writing and delivered to:

a. If to the SUPPLIER:

Address: KNIGHTS a.s., 387 Ke Kaplicce, 252 41 Dolni Brezany, Czech Republic

Phone: +420 257 212 875, +420 603 499 545

Email: knights@knights.cz Attn: Dr. Karl LARYEA

b. If to the BUYER:

Address: Ministry of Food and Agriculture, P. O. Box M37, Accra, Ghana

Phone: +233 302663036

Email: oakoto1@gmail.com

Attn: Dr. Owusu Afriyie Akoto, MP, (Honourable Minister)

- 9.2 The foregoing addresses may be changed by either Party by giving written notice to other Party in accordance with the above.

ARTICLE 10 CONFIDENTIALITY

- 10.1 The Parties agree that all commercial and technical information including specifications, plans, drawings, models, samples, etc. as well as other information and materials entrusted to the BUYER by the SUPPLIER and designated as confidential or which the SUPPLIER acquires about the BUYER in the course of the performance of this Agreement shall not be used for any other purposes other than the performance of that Party's obligations under this Agreement.
- 10.2 Any document or information regardless of whether it was designated as confidential by the BUYER – except for the Agreement itself – shall remain the property of the BUYER and must be returned in all copies to the BUYER after the completion of the performance of the contract by the SUPPLIER if this is required by the BUYER.
- 10.3 The SUPPLIER shall ensure that the above confidentiality obligations applies to all third parties to whom such confidential information is provided to with the consent of the BUYER.
- 10.4 The duty of confidentiality with regards to a particular document or information shall be valid for the period stated by the Party providing such confidential documents or information and where no time limit is specified the duty of confidentiality with regards to such information or document shall be valid for ten (10) years.
- 10.5 The information indicated below shall not be treated as confidential information under this Article:
- i. information which is or which has become publicly known without the fault of the receiving party,
 - ii. information which already was held by the receiving party before its reception from the other party,
 - iii. information which was legally received from any third party.

ARTICLE 11
ADDITIONAL OBLIGATIONS

- 11.1 The BUYER shall be responsible for all import customs connected with the performance of this Agreement including contingent customs and declaration fees for the Equipment in accordance with the laws of the Republic of Ghana.
- 11.2 The SUPPLIER shall ensure the Equipment supplied under this Agreement comply with the standards and legal regulations effective in the Republic of Ghana. Foreign standards may be applied in cases where their requirements and demands are equal or stricter and better than the standards effective in Ghana and same is acceptable under Ghanaian laws.
- 11.3 The SUPPLIER guarantees that all the Equipment meet the technical specifications under this Agreement and will be produced and delivered in the quality required under this Agreement and the general binding regulations, confirming the Equipment are new and unused.
- 11.4 The BUYER shall procure all permits, approvals or licenses from the relevant public institutions, local authorities or administrative institutions in Ghana where such permits, approvals or licenses are required under the laws of Ghana to be obtained by the BUYER.
- 11.5 The BUYER shall, at its own expense ensure the availability of adequate storage space for the storage of the Equipment especially the unloading of the Equipment and transportation to and from warehouses to the places of distribution.

ARTICLE 12
DISCLAIMERS AND WARRANTIES

- 12.1 The SUPPLIER undertakes to grant to the BUYER a warranty of 12 months for the Honda and the Lombardini Engines while extended warranties apply to the following components:
- i. Gearbox DSK 317/S 18 months
 - ii. Active as well as passive accessories 18 months
- 12.2 The Equipment supplied by the SUPPLIER under this Agreement shall be in compliance with the technical specifications specified in Annex 1 and 2

- 12.3 The SUPPLIER warrants, represents, undertakes and guarantees that the Equipment supplied under this Agreement shall:
- i. be free from defects (manifest or latent), in materials and workmanship and remain so for the applicable warranty period after Delivery;
 - ii. be of satisfactory quality and comply with any applicable statutory and regulatory requirements relating to the manufacture, labelling, packaging, storage, handling and delivery of the Equipment;
 - iii. conform with the specifications including the drawings, descriptions given in quotations, estimates, brochures, sales, marketing and technical literature or material (in whatever format made available by the SUPPLIER to the BUYER) supplied by, or on behalf of, the SUPPLIER;
 - iv. be free from design defects;
 - v. be fit for any purpose held out by the SUPPLIER or made known to the SUPPLIER by the BUYER expressly or by implication, and in this respect the BUYER relies on the SUPPLIER's skill and judgement.
- 12.4 The foregoing warranty is subject to the proper installation, operation and maintenance of the Equipment in accordance with installation instructions and the operating manual supplied to the BUYER.
- 12.5 Any warranty claim must be made by the BUYER in writing within fifteen (15) business days of the manifestation of a problem or the identification of a defect.
- 12.6 The obligation of the SUPPLIER under the foregoing warranty is, at the SUPPLIER's option, to repair, replace or correct any such defect that was present at the time of delivery, or to remove the equipment and to refund the purchase price to the BUYER, but shall in any event restore the BUYER to full value on the reported defect.
- 12.7 The "Warranty Period" begins on the date the Equipment is sold by the BUYER and continues for 12 to 18 months, as stated above.
- 12.8 Any repairs under this warranty must be conducted by an authorised Company service representative.

- 12.9 Defects in the Equipment caused by accidents, misuse, misapplication, storage damage (where such is caused by extraneous forces/causes), negligence, or modification to the equipment or its components are not covered under the warranty.
- 12.10 The SUPPLIER does not authorize any person or party to assume or create for it any other obligation or liability in connection with the Equipment except as set forth herein.
- 12.11 The warranty under this Article above is exclusive and in lieu of all other indemnities or warranties, whether express or implied, including the implied warranties of merchantability and fitness for a particular purpose.
- 12.12 On the basis of laboratory trials and practical experience from the manufacturer, the SUPPLIER warrants that the technical service life span of the GLOBAL Multipurpose Mini and Compact Tractors is up to 15 years including all passive accessories.

ARTICLE 13 FORCE MAJEURE

- 13.1 The Parties shall be relieved from liability for partial or full failure to perform their obligations stipulated under this Agreement where (and to the extent) that such non-performance is the result of any event or circumstance caused by a Force Majeure.
- 13.2 A Party's liability is not excluded by any obstacle which occurred no sooner than in the period when the liable party was already in default with the performance of its obligation or if it resulted from its economic relations.
- 13.3 For the purposes of this Article, "Force Majeure" means such extraordinary and unavoidable event outside the control of the Party claiming Force Majeure which it might not have foreseen when concluding this Agreement and which prevents it from the fulfilment of its liabilities following from this Agreement. In addition to other cases, such events include, in particular: wars, revolutions, floods, epidemics, quarantine restrictions, transport embargoes, general strikes and strikes of a whole industry branch.
- 13.4 Circumstances of Force Majeure do not include mistakes or negligence on the part of the Party claiming the Force Majeure.
- 13.5 A Party claiming the occurrence of a Force Majeure shall inform the other contracting Party without delay but not later than five (5) business days from

the occurrence of such an event by fax, e-mail or telegram with subsequent confirmation by registered letter. The other party shall be informed in the same manner about the fact that the circumstances of Force Majeure no longer exist.

- 13.6 Upon request, the Party claiming the Force Majeure shall submit to the other Party prima facie evidence of such an event.

ARTICLE 14 DISPUTE SETTLEMENT

- 14.1 Any dispute, claim arising out of or in connection with this Agreement (including a dispute relating to the existence, validity or termination of this Agreement or any non-contractual obligation arising out of or in connection with this Agreement) (a "Dispute") shall be amicably settled between the Parties by negotiation.
- 14.2 In the event that no amicable solution is reached within thirty (30) days, the dispute, controversy or claim arising out of or in connection with this Agreement including its conclusion, interpretation, performance, breach, termination or invalidity shall be referred to and finally resolved by arbitration under the United Nations Commission on International Trade Law Rules of Arbitration (UNCITRAL).
- 14.3 An award made by the arbitrators will be final and binding on all the Parties to the arbitration.
- 14.4 The arbitral tribunal shall consist of three arbitrators. The BUYER shall nominate one arbitrator; the SUPPLIER shall nominate the second arbitrator, and a third arbitrator (who shall act as Chairman) shall be appointed by the arbitrators nominated by the Parties hereto or, in the absence of an agreement on the third arbitrator within 30 business days of the appointment of the second arbitrator, a person appointed as the third arbitrator according to the UNCITRAL Rules of Arbitration.
- 14.5 The seat of arbitration shall be Accra, Ghana.
- 14.6 The language of the arbitration shall be English.

ARTICLE 15 ASSIGNMENT

This Agreement may not be assigned by either Party without the prior written consent of the Other Party.

**ARTICLE 16
TERMINATION**

- 16.1 This Agreement may be terminated by the parties by mutual written consent.
- 16.2 A Party may unilaterally terminate this Agreement for failure by the other Party to perform its obligations where such default or failure is not remedied by the defaulting Party within thirty (30) business days of the default or failure being brought to its notice.

**ARTICLE 17
GOVERNING LAW**

This Agreement and any non-contractual obligations arising out of or in connection with it are governed by the laws of Ghana.

**ARTICLE 18
ENTIRE AGREEMENT**

- 18.1 This Agreement sets out the entire agreement between the Parties hereto. Neither Party has entered into this Agreement in reliance upon any representation, warranty or undertaking by the other Party that is not expressly set out or referred to in this Agreement.
- 18.2 The Parties agree that Article 18.1 does not exclude any liability which may arise from a fraudulent representation by a Party.

**ARTICLE 19
INVALIDITY**

- 19.2 If one or more provisions of this Agreement, or the application of any provision to any party or circumstance, is held invalid, unenforceable, or illegal in any respect, the remainder of this Agreement and the application of the provision to other parties or circumstances shall remain valid and in full force and effect unless it can be concluded from the circumstances that, in the absence of the provision found to be null and void, the Parties would not have concluded this Agreement.
- 19.3 The Parties shall use all reasonable efforts to replace all provisions found to be null and void by provisions that are valid under the applicable law and come closest to the original intentions of the Parties.

IN WITNESS WHEREOF the Parties hereto have each caused this Agreement to be executed and delivered by their duly authorized representative as of the date first above written.

FOR THE BUYER

FOR THE SUPPLIER

NAME:.....

NAME:.....

DESIGNATION:.....

DESIGNATION:.....

SIGNATURE:.....

SIGNATURE:.....

DATE:.....

DATE:.....

WITNESS FOR BUYER

WITNESS FOR SUPPLIER

NAME:.....

NAME:.....

DESIGNATION:.....

DESIGNATION:.....

SIGNATURE:.....

SIGNATURE:.....

DATE:.....

DATE:.....

SCHEDULE 2

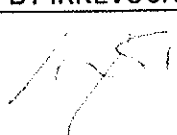
KNIGHTS Transfer of Technologies		PROFORMA INVOICE		
Knights a.s. Ke Kapličky 387 252 41 Dolní Břežany Czech Republic		Proforma Invoice No.: 180008/02 Consignee: Ministry of Food and Agriculture P. O. BOX M37 Accra Ghana		
Tel: +420 257 212 875 Fax: +420 241 400 549 E-mail: knights@knights.cz URL: www.knights.cz		Due Date: 31st May 2018 Date of Issue: 26th March 2018 Date of Taxable Fulfillment: N/A		
Department: Import & Export Contact person: Dr. Karl Laryea Direct line: +420 603 499 545		Terms and conditions of payment 100% IRREVOCABLE DEFERRED LETTER OF CREDIT INTO ACCOUNT NO.: 198096430/0300 SWIFT CODE: CEKO CZPP, IBAN CZ09 0300 0000 0001 9809 6430		
Delivery terms: CIF - TEMA		Bankers: Ceskoslovenska obchodni banka, a.s. Na Příkopě 18 115 20 Prague 1, Czech Republic		
No.	PRODUCT DESCRIPTION	QTY	UN PRICE in EUR	QTY PRICE in EUR
	FULLY LOADED SET			
1.	Minitractor GLOBAL (4432)	300	1 360,00	408 000,00
2.	Complete hitch BZN-002 (3710)	300	190,00	57 000,00
3.	Adjusting element NT-3 (3711)	300	70,00	21 000,00
4.	Two-sided plough APH-352 (3611)	300	125,00	37 500,00
5.	Rottary tiller KYT-357 (6001)	300	260,00	78 000,00
6.	Tipping trailer ANV-400 (4410)	300	420,00	126 000,00
7.	Drum mower BDR-650 V (4399)	300	640,00	192 000,00
8.	Irrigation pump DZP-005/S (3517)	300	585,00	175 500,00
9.	Rotary weeder RTP-2/S (4347)	300	310,00	93 000,00
10.	Set of basic tools and spare parts	300	100,00	30 000,00
	SUBTOTAL		4 060,00	1 218 000,00
12.	TRANSPORTATION (By Sea - 40" FCL)	---	---	90 000,00
13.	INSURANCE (All Risks)	---	---	10 000,00
	Origin: Czech Republic (EU)			
TOTAL AMOUNT TO BE PAID BY IRREVOCABLE LC:				1 318 000,00
Knights a.s. Signature		 KNIGHTS Transfer of Technologies Knights a.s., Ke Kapličky 387, 252 41 Dolní Břežany, Czech Republic IČO: 25276026, DIČ: CZ 252 760 26 Stamp		

Registered office: Ke kapličky 387, 252 41 Dolní Břežany, Czech Republic
 Registered in the Company Register of the Regional Court in Prague, Section B, File No. 12299
 IČO: 252 760 26, DIČ: CZ 252 760 26

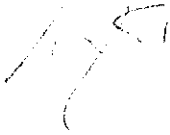
KNIGHTS Transfer of Technologies		PROFORMA INVOICE		
Knights a.s. Ke kapličky 387 252 41 Dolní Břežany Czech Republic		Proforma Invoice No.: 180008/01 Consignee: Ministry of Food and Agriculture P. O. BOX M37 Accra Ghana		
Tel: +420 257 212 875 Fax: +420 241 400 549 E-mail: knights@knights.cz URL: www.knights.cz		Due Date: 31st May 2018		
Department: Foreign Services Contact Person: Dr. Karl Laryea Direct Line: 00420 603 499 545		Date of Issue: 26th March 2018 Date of Taxable Fulfillment: N/A		
Delivery Terms		Bankers		Terms and Conditions of Payment
CIF - TEMA		Ceskoslovenska obchodni banka, a.s. Radlicka 333/150 150 57 Praha 5, Czech Rep.		100% IRREVOCABLE DEFERRED LETTER OF CREDIT INTO ACCOUNT NO. 198096430/0300 SWIFT CODE: CEKO CZPP, IBAN CZ09 0300 0000 0001 9809 6430
No.	PRODUCT DESCRIPTION	QTY	UN PRICE in EUR	QTY PRICE in EUR
1	AGROMECHANIKA TRACTOR AGT 850	100	17 500,00	1 750 000,00
2	CABRIO COMPACT TRACTOR - 50 HP	120	17 980,00	2 157 600,00
3	Three Sided Tipping Trailer ANS - 1900	220	3 500,00	770 000,00
4	Rotary Tiller AKR - 140	220	2 980,00	655 600,00
5	Rice Cutting Accessories RCA - 1500	120	3 900,00	468 000,00
6	Rice Thresher Accessories RSR-100	120	3 800,00	456 000,00
7	Mulcher MUL - 1500	220	2 980,00	655 600,00
8	Two Disc Plough - KDP 513	220	2 560,00	563 200,00
9	Mist Blower and Boom Sprayers	150	3 500,00	525 000,00
10	Tools and Spare Parts Kit for Each Set	1 Lot		216 000,00
10	Transportation (Ocean Freight)	1 Lot		425 000,00
11	Insurance (All Risks)	1 Lot		40 000,00
Origin: Czech Republic (EU)				
TOTAL AMOUNT TO BE PAID BY IRREVOCABLE LC:				8 682 000,00
Knights a.s. Signature		 KNIGHTS Transfer of Technologies KNIGHTS a.s., Ke Kapličky 387, 252 41 Dolní Břežany, Czech Republic, IČO: 25276026, DIČ: CZ 25276026 Stamp		

Registered office: Ke kapličky 387, 252 41 Dolní Břežany, Czech Republic
 Registered in the Company Register of the Regional Court in Prague, Section B, File No. 12299
 IČO: 252 760 26, DIČ: CZ 252 760 26

Annex 1

Technical Specification of GLOBAL Multipurpose Mini Tractor:

Product	Ref No.	Type	Description of product	Weight
GLOBAL MINI TRACTOR IV	4432	GLOBAL TRACTOR	Engine unit, Engine Honda GSV 190 + VR-02, power 6.5HP, max. revolutions 3600 r.p.m., with handlebars adjustable in 3 positions, Gearbox DSK-317.1	130 kg
TWO SIDED PLOUGH	3611	APH-352	Two-sided plough APH-352. Useful for ploughing till maximum depth of 20 cm from terrain level.	32 kg
HITCHES	3710	BZN-002	Hitch for mini tractors DSK 317 (1.35kg and 2.5kg weights, weight support included)	51 kg
ADJUSTING ELEMENT	3711	NT-3	Adjusting element NT-3 to precise adjusting of implements	7 kg
TIPPING TRAILER	4410	ANV-400	Tilting Semi-Trailer ANV- 400 (wheels 12"). Load capacity 400 kg, max. speed 15km/hour, inner length of loader 1330 mm, inner width of loader 1020 mm, height 300 mm	125 kg
IRRIGATION PUMP	3517	DZP-005/S	Water Pump IRIS, power output 100l/min	23 kg
ROTARY WEEDER	4347	RTP-2/S	The rotary hoe can be used during the growing season, even on large plots and in tree nurseries. Working width is from 16, 22, 32 up to 38cm Maximum working depth is from 2 to 8cm	29 kg
DRUM MOWER	4399	BDR-650V	Self-propelled drum mower for 4-stroke engine, working width 62 cm, 4 cutting blades with double-sided edges and swivel attachment, big 8" wheels with arrow (tractor) pattern, two different travel speeds	43 kg
ROTTARY TILLER	6001	KYT-125	Rotary cultivator for GLOBAL TRACTOR, working width 80 - 125 cm (incl. KUK-125, N-3)	48 kg

Compact Tractor – CABRIO 4WD / 50 HP Excellent

Engine – Lombardini Diesel	Model: LDW2204CHDW
Power Output	50 HP
Max. Engine speed	3 000 rpm
Piston Displacement	2 199 cm ³
Torque Nm@r.p.m.	144 / 2 000
Cooling	Water
Number of Cylinders	4
Gearbox	Mechanical
Number of Gears	8 forwards / 8 backwards
Speed Range km/h at 2 200 rpm	Forwards: 1,49 – 18,16 / Backwards: 1,49 - 14
Front Tyres	Standard 10x75x15,3
Rear Tyres	Standard 20x11,2
Front Three-Point Hitch	ISO 730 / 1N*
Rear Three-Point Hitch	ISO 730 / 1
PTO Shaft Speed - front	1 000 rpm
PTO Shaft Speed - rear	540 – 1 000 rpm
Lifting Force – front hitch	5 100 N
Lifting Force – rear hitch	6 200 N
Mechanical Brakes	4 x Dry Disc Brake
Front Differential	Front Differential Lock
Rear Differential	Rear Differential Lock
Steering	Hydraulic
Hydraulic Pump Capacity	17 – 35* l/min.
Operating Pressure of Hydraulics	16 Mpa
Specific Fuel Consumption	265 g.kWh +- 10%
Fuel Tank Capacity	19 L
Turning Radius	2,4 m
Weight	1 180 kg

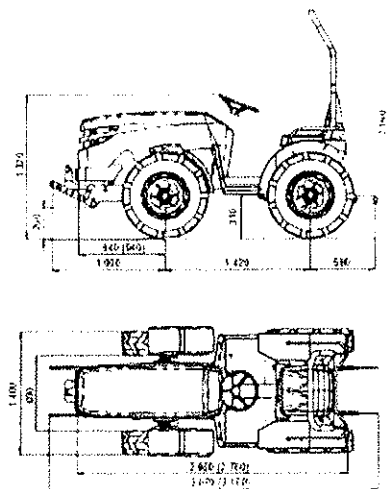
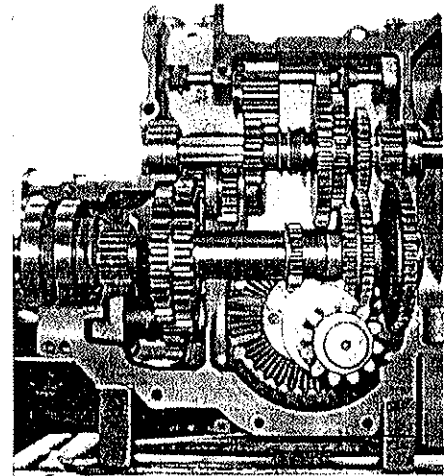
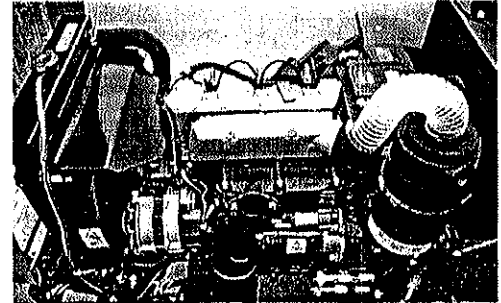

Annex 2

Technical Specifications of CABRIO Compact Tractor

Compact Tractor – CABRIO 4WD / 50 HP Excellent

Engine – Lombardini Diesel	Model: LDW2204C11DW
Power Output	50 hp
Max. Engine speed	3 000 rpm
Piston Displacement	2 199 cm ³
Torque Nm@r.p.m.	144 / 2 000
Cooling	Water
Number of Cylinders	4
Gearbox	Mechanical
Number of Gears	8 forwards / 4 backwards
Speed Range km/h at 2 200 rpm	Forwards: 1,49 – 18,16 / Backwards: 1,49 - 14
Front Tyres	Standard 10x75x15,3
Rear Tyres	Standard 20x11,2
Front Three-Point Hitch	ISO 730 / 1N*
Rear Three-Point Hitch	ISO 730 / 1
PTO Shaft Speed - front	1 000 rpm
PTO Shaft Speed - rear	540 – 1 000 rpm
Lifting Force – front hitch	5 100 N
Lifting Force – rear hitch	6 200 N
Mechanical Brakes	4 x dry disc brake
Front Differential	Front differential lock*
Rear Differential	Rear differential lock
Steering	Hydraulic
Hydraulic Pump Capacity	17 – 35* l/min.
Operating Pressure of Hydraulics	16 Mpa
Specific Fuel Consumption	265 g.kWh +- 10%
Fuel Tank Capacity	19 L
Turning Radius	2,4 m
Weight	1 180 kg

Three-side tipping trailer ANS-1500

Three-side tipping trailer ANS-1500

Width	1 500 mm
Weight	350 kg
Loading area	3,70 m ²
Loading space	1,60 m ³
Wheel track	1 210 mm
Payload	1 500 kg
Towing eye	40 mm
Tipping angle	39°

Rotary tiller AKR-140

Overall length	870 mm
Overall width	1 500 mm
Operating width	1 360 mm
Operating depth	150 mm
Overall height	770 mm
Max. operating slope ability	8°
PTO shaft speed	540 or 1 000 rpm
Tiller weight	184 kg

Disk plough KDP-513

	KDP 513
Number of Disc	3
Total Length (L)	1 700 mm
Total Width (N)	870 mm
Total Height (H)	1 050 mm
Max. Working Depth	20 cm
Working Width (F)	79 cm
Space of Disc (B)	43 cm
Disc Diameter	510 mm
Required Power	35 – 40 hp
Total Weight	240 kg

Mulcher MUL-1500

Operating width	1 500 mm
Overall width	1 670 mm
Overall height	710 mm
Overall length	720 mm
Weight	180 kg
Rotor speed	2 800 rpm
Min. power of tractor required	25 hp
Driving shaft speed	1 000 or 540 rpm
Number of blades	72

In case of reply the
number and date of this
letter should be quoted.

My Ref. No OPGA.3/3/031118

Your Ref. No.....



REPUBLIC OF GHANA

OFFICE OF THE PRESIDENT
P.O. BOX 1627
ACCRA
TEL: 0302-201000/2

CONFIDENTIAL

3rd November, 2018

REQUEST FOR APPROVAL FOR €10,000,000.00 LOAN UNDER THE CZECH
EXPORT BANK FACILITY TO GOVERNMENT OF GHANA FOR THE SUPPLY OF
SETS OF CABRIO COMPACT TRACTORS AND GLOBAL SYSTEM FOR
DISTRIBUTION TO SMALL AND MEDIUM SCALE FARMERS

Cabinet at its Fourth Government Retreat held on Saturday, 3rd November, 2018 at Senchi considered a report of the Cabinet Committee on Economic Matters on the above Memorandum submitted jointly by the Ministers for Agriculture and Finance.

2. The Memorandum requested Cabinet to consider, approve and recommend to Parliament for ratification, a request for a loan of Ten Million Euros (€10,000,000.00) from Czech Export Bank (CEB) to the Ministry of Agriculture for the supply of Global Multipurpose Mini Tractors (Global System) and CABRIO Compact Tractors.
3. Cabinet approved the Memorandum and recommended same to Parliament for consideration.
4. I should be grateful if you could take requisite action on the decision by Cabinet.

MERCY DEBRAH-KARIKARI
SECRETARY TO THE CABINET

THE HON. MINISTER FOR AGRICULTURE

THE HON. MINISTER FOR FINANCE

cc: Chief of Staff
Secretary to the President
Secretary to the Vice President
Hon. Minister for Parliamentary
Affairs
Chairperson, Cabinet Committee on
Economic Matters